

Wending our Way Down Opioid Metabolism Pathways

JoAn Laes, M.D., Hennepin County Medical Center

Lewis Nelson, M.D., Rutgers New Jersey Medical School

Soumya Pandalai, M.D., Banner Health

**Stephanie T. Weiss, M.D., Ph.D., National Institute on Drug
Abuse**

American Society of Addiction Medicine 53rd Annual Conference

Disclosure Information

☀ JoAn Laes, M.D., Hennepin County Medical Center

☀ Commercial Interests: **No Disclosures**

☀ Lewis Nelson, M.D., Rutgers New Jersey Medical School

☀ Commercial Interests: **No Disclosures**

☀ Soumya Pandalai, M.D., Banner Health

☀ Commercial Interests: **No Disclosures**

☀ Stephanie T. Weiss, M.D., Ph.D., National Institute on Drug Abuse

☀ Commercial Interests: **No Disclosures**



Learning Objectives

- ☀ Review common urine drug testing technologies and classification of opiates/opioids
- ☀ Recognize the chemical relationships between common opiates and semi-synthetic opioids
- ☀ Identify four factors that may complicate urine drug testing interpretation

A wide-angle photograph of a vast field of red poppies. The flowers are in full bloom, with vibrant red petals and dark centers, set against lush green foliage. A narrow, light-colored path or dirt road winds through the field from the foreground towards the center. In the background, a line of dark green trees is visible on the left, and rolling hills or mountains stretch across the horizon under a dramatic sky. The sky is filled with large, textured clouds, with a bright, golden light breaking through near the horizon, suggesting a sunset or sunrise. The overall mood is serene and natural.

Urine Drug Testing Review

Problem: we want to know if the patient or client is “on drugs.”

Can't we just send “The Tox Screen”?



Unfortunately, no....

People who are using drugs People who are not using drugs

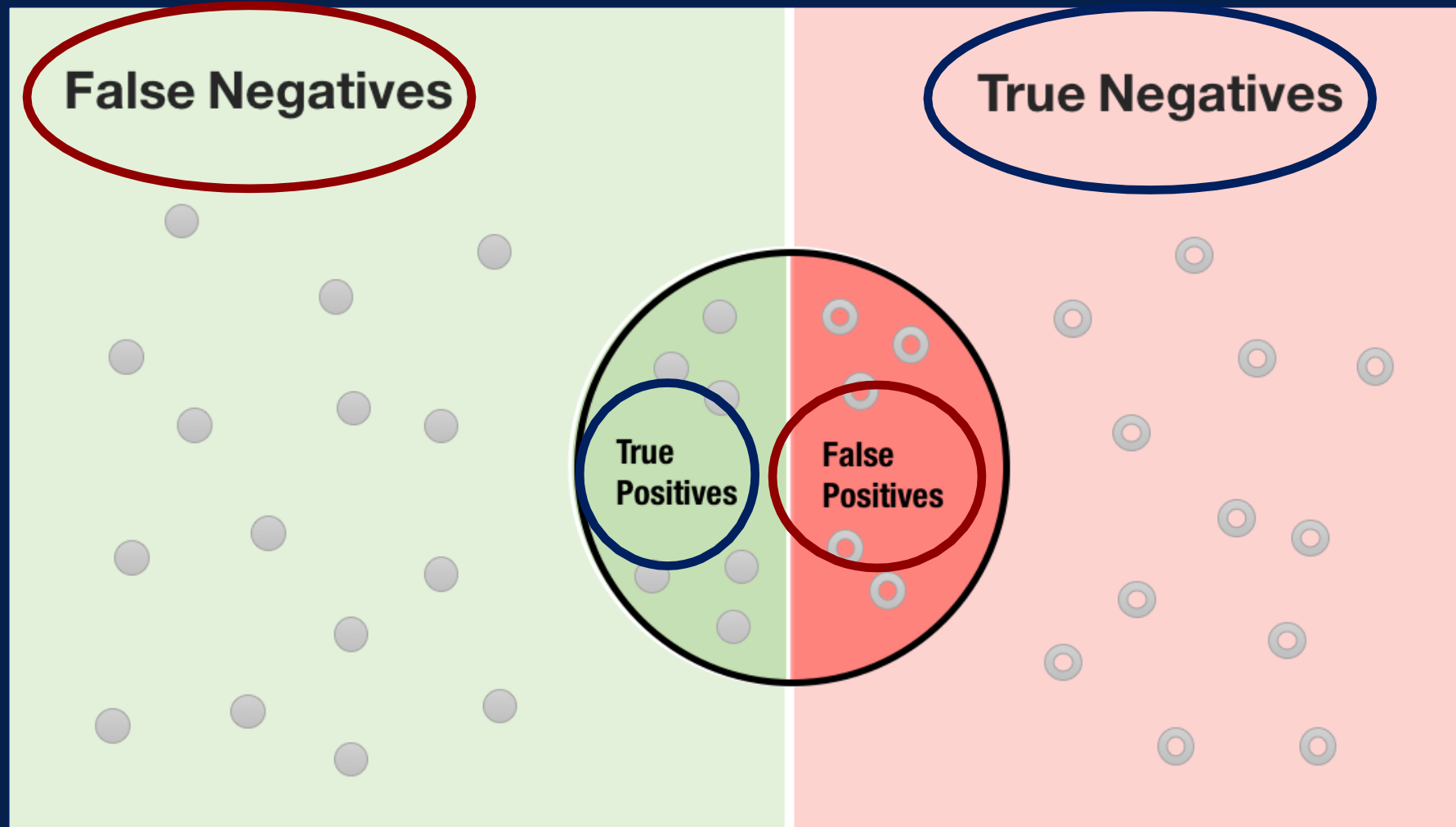

What is a Urine Drug Screen (UDS)?

- ☀️ Immunoassay to detect common street drugs of abuse or their metabolites in urine

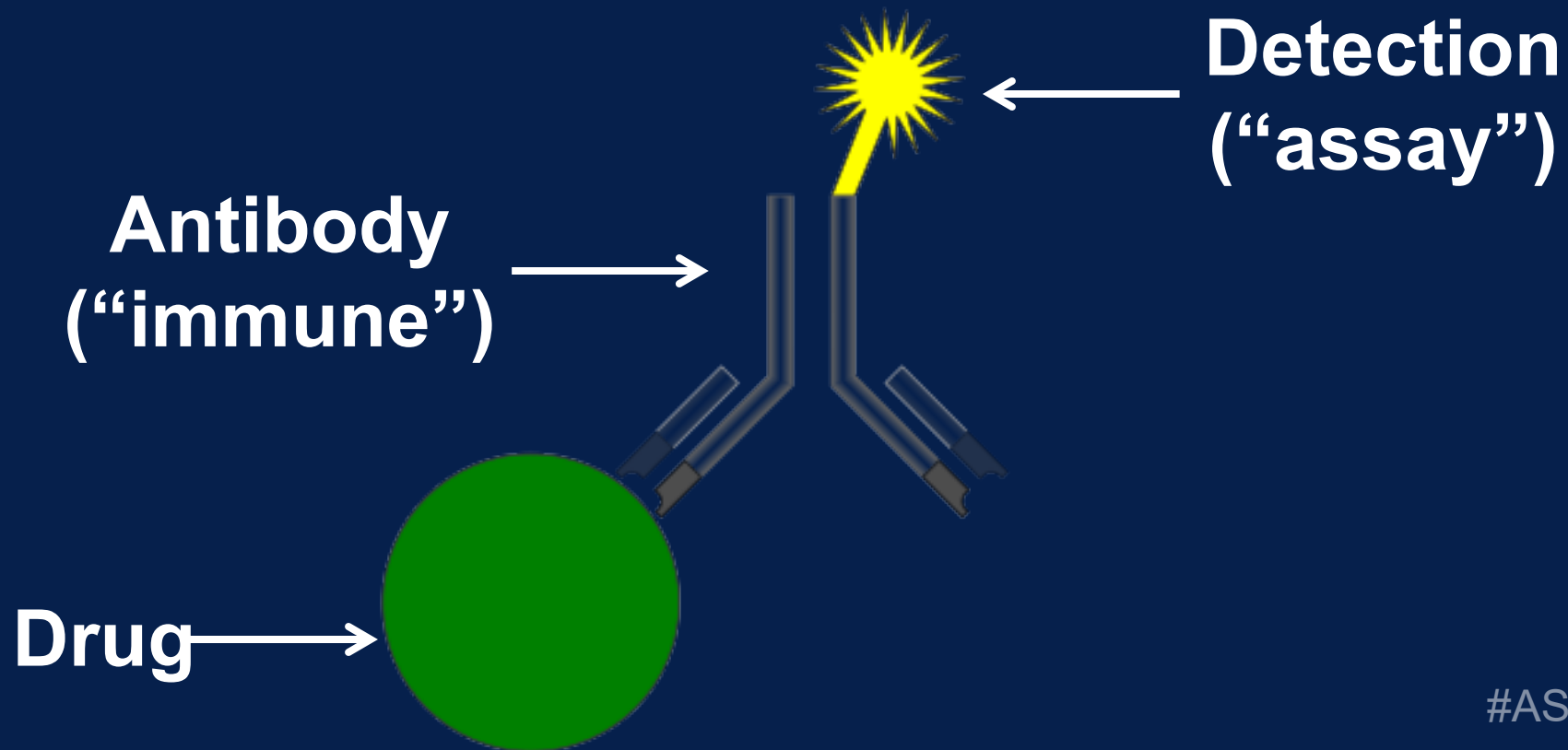

Why do we even have a UDS?

- ☀ Developed by the Department of Transportation (DOT) in 1991 to drug test truck drivers

DOT



DOT drug screen tests for five drugs:

- Marijuana
- Cocaine
- Opiates
- Amphetamines /Methamphetamines
- PCP

Non-DOT

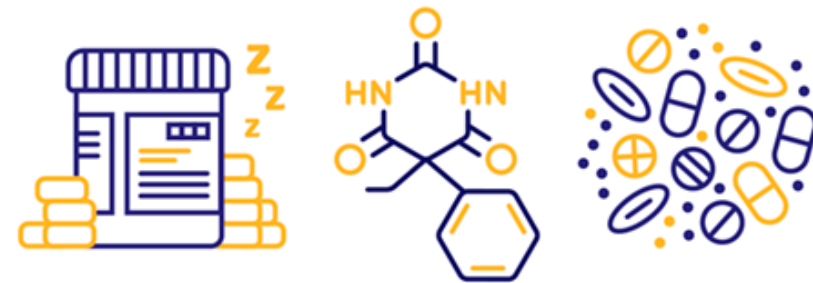

Same as DOT but also tests the following:

- Benzodiazepines
- Propoxyphene
- Barbiturates
- Quaaludes
- Methadone

Can also include test for hallucinogens, anabolic steroids, prescription painkillers, and ecstasy.

Problem: the UDS does not test for most drugs

- ☀ Synthetic cathinones (“bath salts”)
- ☀ Synthetic cannabinoids (“spice” or “K2”)
- ☀ Synthetic opioids (fentanyls, U-47700, isotonitazene)
- ☀ Rx medications (gabapentin, “Z-drugs”)
- ☀ OTC medications (DXM, diphenhydramine)
- ☀ Hydrocarbons (“poppers” or “whippets”)
- ☀ Herbals: kratom, *Salvia*



Solution: Get Confirmatory Testing (Comp Tox)

Liquid Chromatography-Mass Spectrometry

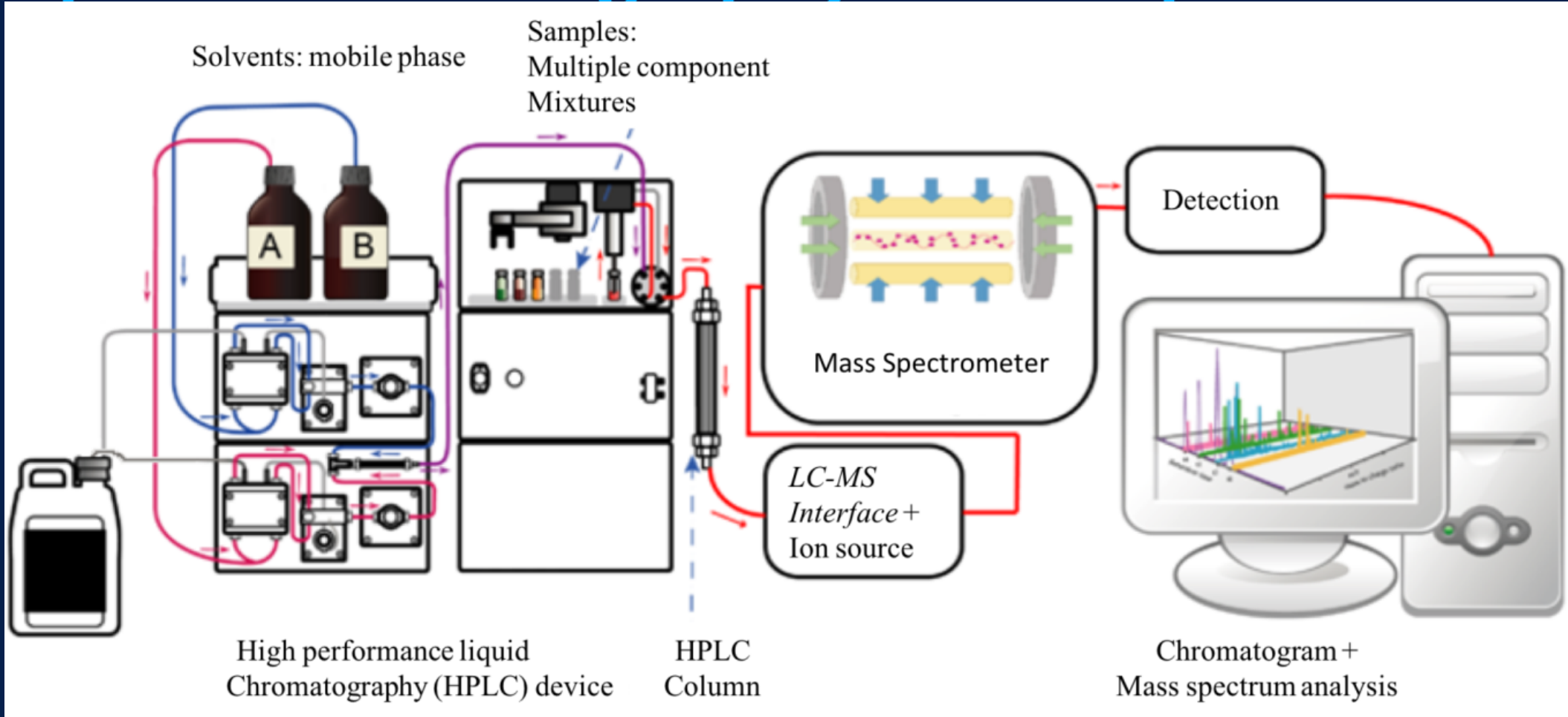

Chromatography General Principles

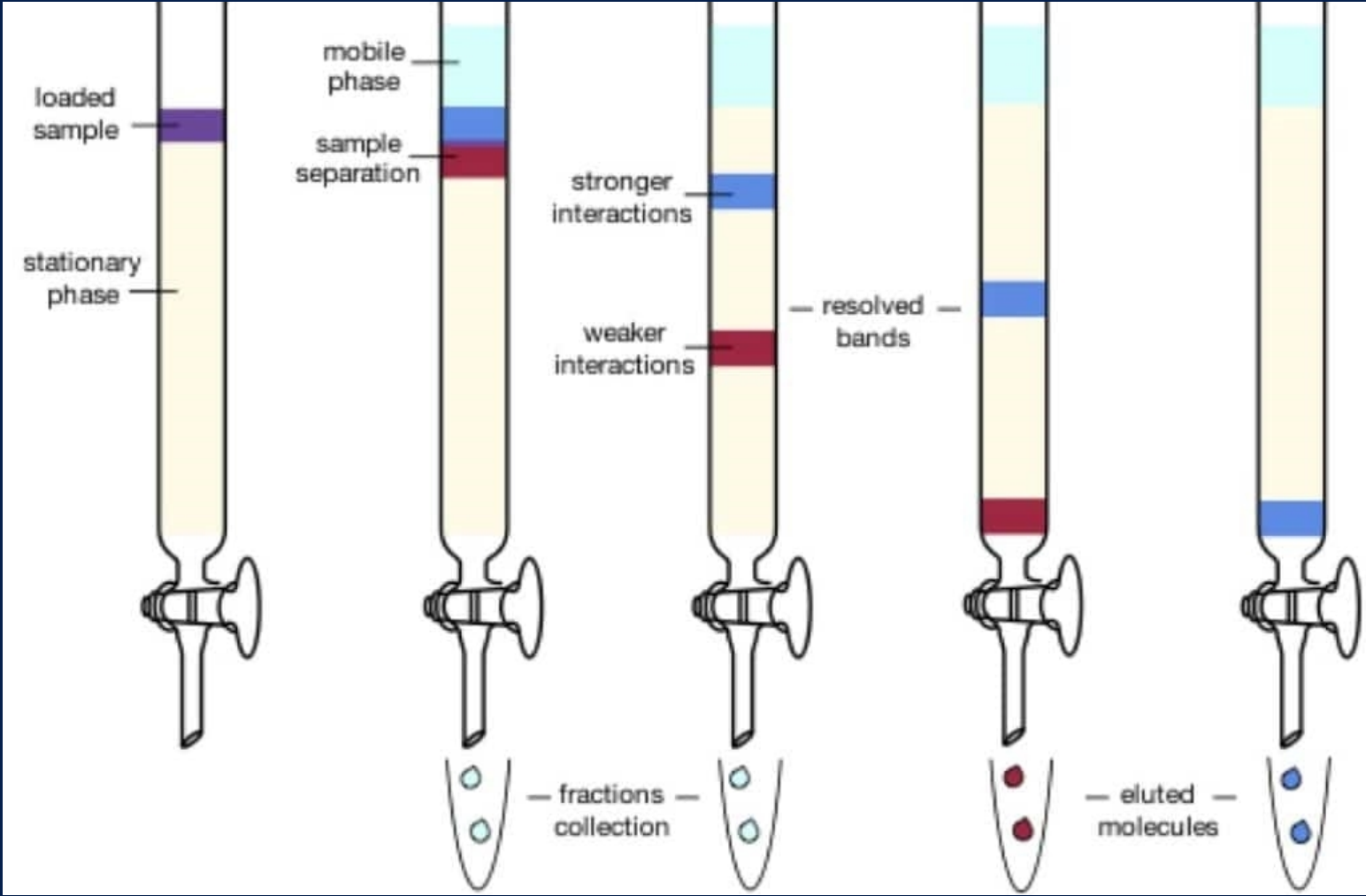

#ASAMAnnual2022

UDT Advantages and Disadvantages

ADVANTAGES	DISADVANTAGES
Urine Drug Screens (UDS/Immunoassays)	
Lower cost	Can't identify specific drugs in a class
Rapid turnaround time	Can't detect many compounds
Readily available (POC testing)	Cutoffs vary from test to test
Adequate sensitivity	High false-positivity rate
Confirmatory Testing (Chromatography/Mass Spec, Confirmatory Test)	
Can identify the drug of interest	Expensive
Highly sensitive and specific	Slower turnaround time
No cross-reactivity	High expertise level required

A wide-angle photograph of a vast field of red poppies. The flowers are in full bloom, with vibrant red petals and green foliage. A narrow, light-colored path or dirt road winds through the field from the foreground towards the center. In the background, there are dark, silhouetted trees on the left and rolling hills under a dramatic sky. The sky is filled with large, textured clouds, with a bright, golden light breaking through near the horizon, suggesting a sunset or sunrise. The overall mood is serene and natural.

Interpretation of Urine Drug Testing by Health Care Providers

Quick Quiz

In a patient prescribed Tylenol #3 (codeine + acetaminophen), one would reasonably expect the following to be detected in the urine?

- A. Codeine
- B. Oxycodone
- C. Morphine
- D. All of the above
- E. A and C only

Quick Quiz

In a patient prescribed MS Contin (morphine), one would reasonably expect the following to be detected in the urine?

- A. Morphine
- B. Oxycodone
- C. Codeine
- D. All of the above
- E. A and C only

Quick Quiz

A patient on Oxycontin (oxycodone) is administered a UDS. He states he ate a poppy seed danish for breakfast. What substances might reasonably be detected in the urine?

- A. Morphine
- B. Oxycodone
- C. Codeine
- D. All of the above
- E. A and C only

How Good Are Physicians at Interpreting UDS?

Attendings
of multiple
specialties
who treat
pain and
addiction

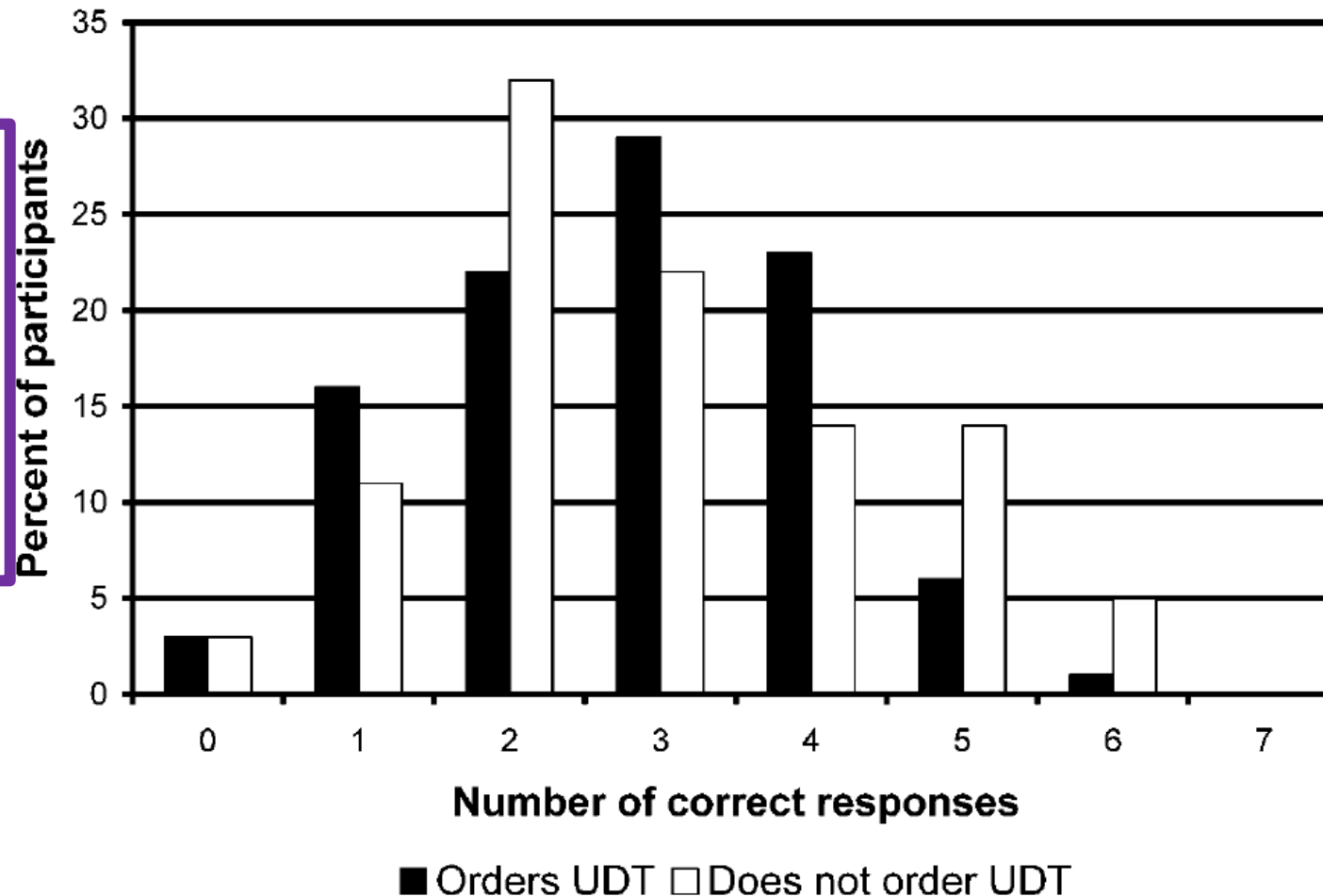

How Good Are Physicians at Interpreting UDS?

Family
medicine
attendings
at a review
course

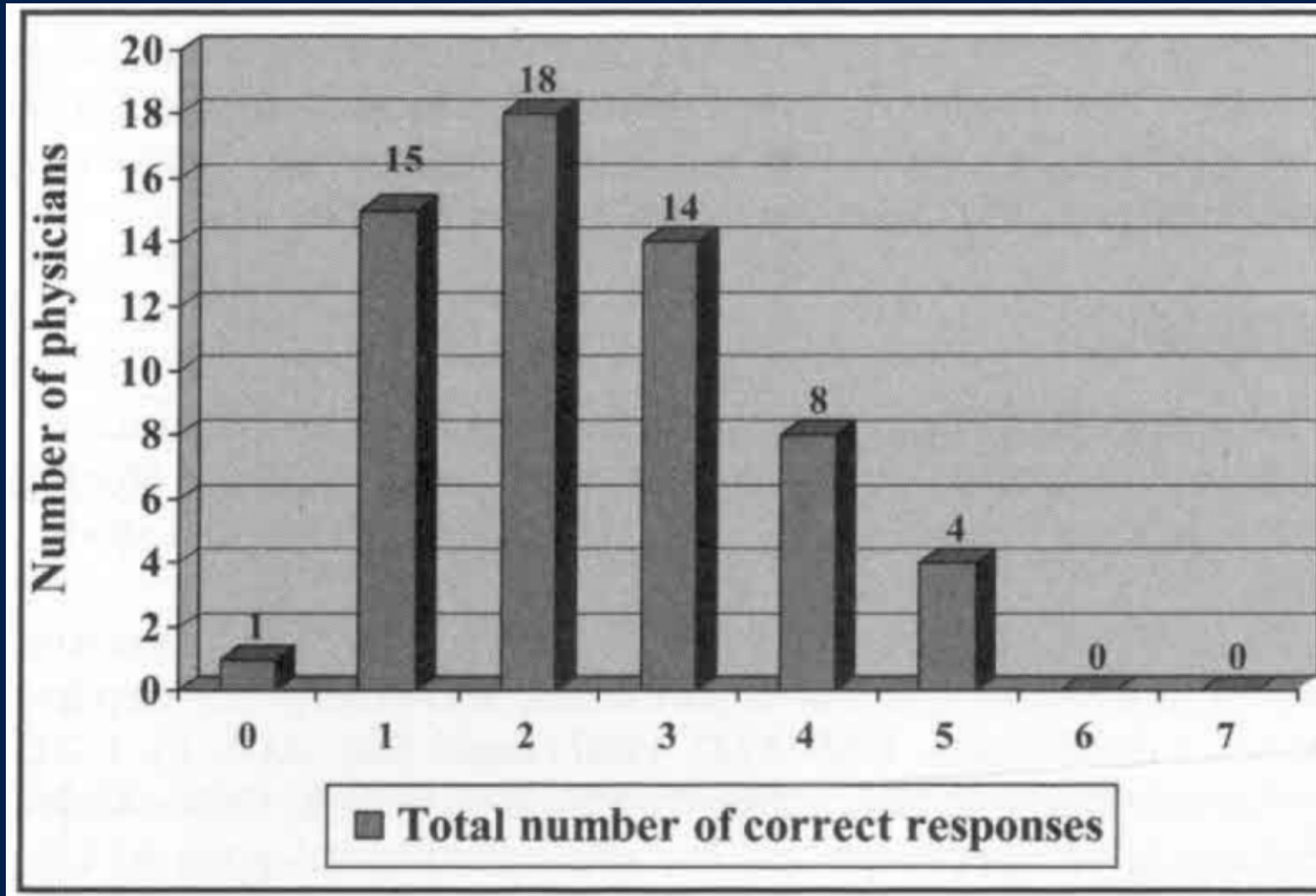

How Good Are Physicians at Interpreting UDS?

Internal medicine residents	Total n=99	Confident n=55	Not confident n=44
	n (%)	n (%)	n (%)
Knowledge questions, % of residents who answered correctly†			
Q1-4. Identify substance(s) expected to be detected in urine of a patient who is:			
prescribed acetaminophen/codeine	29 (29.3)	14 (25.5)	15 (34.1)
prescribed morphine	68 (68.7)	36 (65.4)	32 (72.7)
using heroin	10 (10.1)	6 (10.9)	4 (9.1)
ingesting poppy seed danish	20 (20.2)	12 (21.8)	8 (18.2)
Q5. Identify that second-hand marijuana smoke exposure would not cause a positive urine drug screen for cannabis	74 (74.8)	43 (78.2)	31 (70.5)
Q6. Identify valid reasons for a negative urine opiate screen in a patient prescribed opioids	42 (42.4)	27 (49.1)	15 (34.1)
Q7. Identify need for confirmatory testing	58 (58.6)	30 (54.6)	28 (63.6)
UDT Knowledge Score			
Score of 4 or greater, n (%) of residents	27 (27.3)	15 (27.3)	12 (27.3)
Mean score (SD)	3.0 (1.2)	3.1 (1.2)	3.0 (1.2)

How Good Are Physicians at Interpreting UDS?

**Psychiatry
residents**

Knowledge test results	Correct (%)
Q1 correct	26 (32.1%)
Q2 correct	71 (88.8%)
Q3 correct	21 (25.9%)
Q4 correct	9 (11.3%)
Q5 correct	69 (85.2%)
Q6 correct	19 (23.5%)
Q7 correct	73 (90.1%)
Total score	3.5 (SD 1.1, range 1-6)

What about Chromatography-Mass Spec?

Retrospective chart review of 160 comp tox interpretations (half aberrant, half compliant) by institution clinical chemists

Providers incorrectly interpreted UDT approximately one-quarter of the time across all disciplines.

Our study demonstrated that providers across medical specialties have difficulty on correctly interpreting UDT by LC-MS/



A wide-angle photograph of a vast field of red poppies. The flowers are in full bloom, with vibrant red petals and dark centers, set against lush green foliage. A narrow, light-colored path or dirt road winds through the field from the foreground towards the middle ground. In the background, a line of dark green trees is visible on the left, and rolling hills or mountains stretch across the horizon under a sky filled with dramatic, layered clouds. The lighting suggests either early morning or late afternoon, with a warm, golden glow breaking through the darker parts of the sky.

Opiate and Semisynthetic Opioid Pathways

Opiates vs. Semisynthetic and Synthetic Opioids

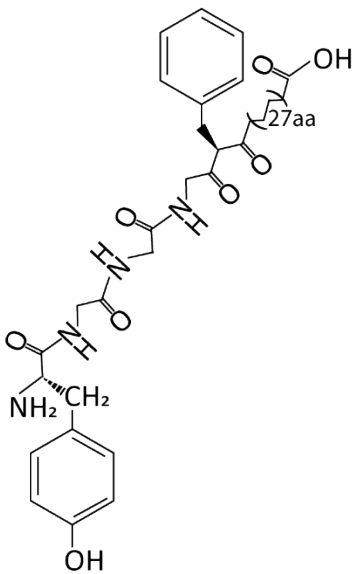

β-endorphin

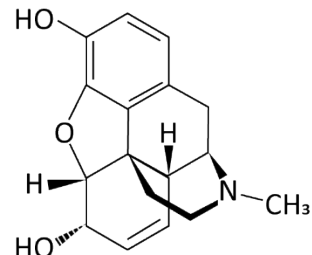

Morphine

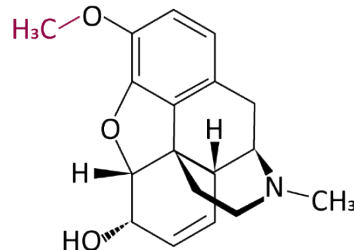

Codeine

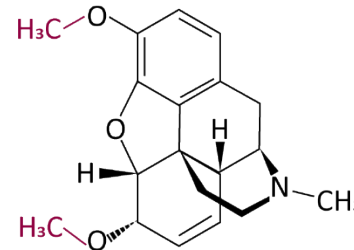

Thebaine

Natural opioids

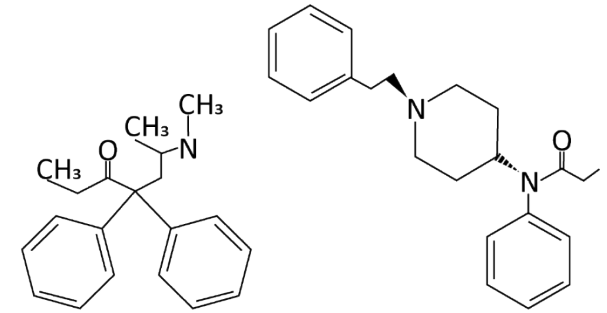

Methadone

Fentanyl

Synthetic opioids

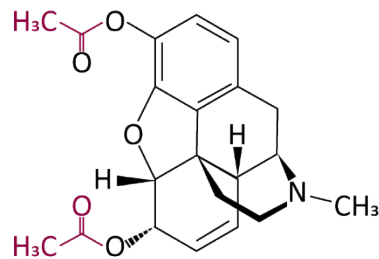

Heroin

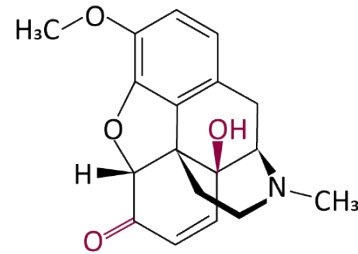

Oxycodone

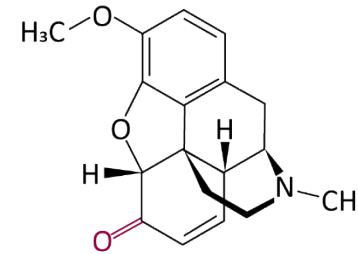

Hydrocodone

Semisynthetic opioids

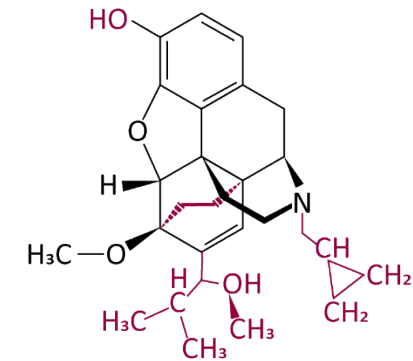

Buprenorphine

Opiate/Semisynthetic Opioid Case

☀ 50 y/o female w/ PMH chronic pain s/p multiple vertebral fractures

☀ Medications

☀ Methadone 20 mg TID

☀ IR Morphine 30 mg 5x/day

☀ Gabapentin 1200 mg BID

☀ Duloxetine 60 mg qday

☀ Celecoxib 200 mg BID

Immunoassay Results

Test Performed	Qualitative Result	Quantitative Result (ng/mL)	Assay Cutoff (ng/mL)
Opiates	Positive	>800	50
Methadone	Positive	>500	130

Methadone	Immunoassay	Positive	>500	130
Methadone	Mass spectrometry	Positive	2911	100



Table 1. Laboratory Test Results

Test Performed	Method of Detection	Patient Values (Qualitative)	Patient Values, ng/mL	Assay Cutoff, ng/mL
Opiates	Immunoassay	Positive	>800	50
Codeine	Mass spectrometry	Positive	254	100
Morphine	Mass spectrometry	Positive	>50 000	100
Hydrocodone	Mass spectrometry	Negative		100
Hydromorphone	Mass spectrometry	Positive	5792	100
Norhydrocodone	Mass spectrometry	Negative		100
Oxycodone	Mass spectrometry	Negative		100



HOW WOULD YOU INTERPRET THESE RESULTS?

- A.** The patient is taking methadone and morphine.
- B.** The patient is taking methadone and codeine.
- C.** The patient is taking methadone, hydromorphone, and codeine.
- D.** The patient is taking methadone, morphine, hydromorphone, and codeine.

Remember: she is prescribed IR morphine and methadone

Remember: she is positive on COMP TOX for morphine, codeine, and hydromorphone

#ASAMAnnual2022

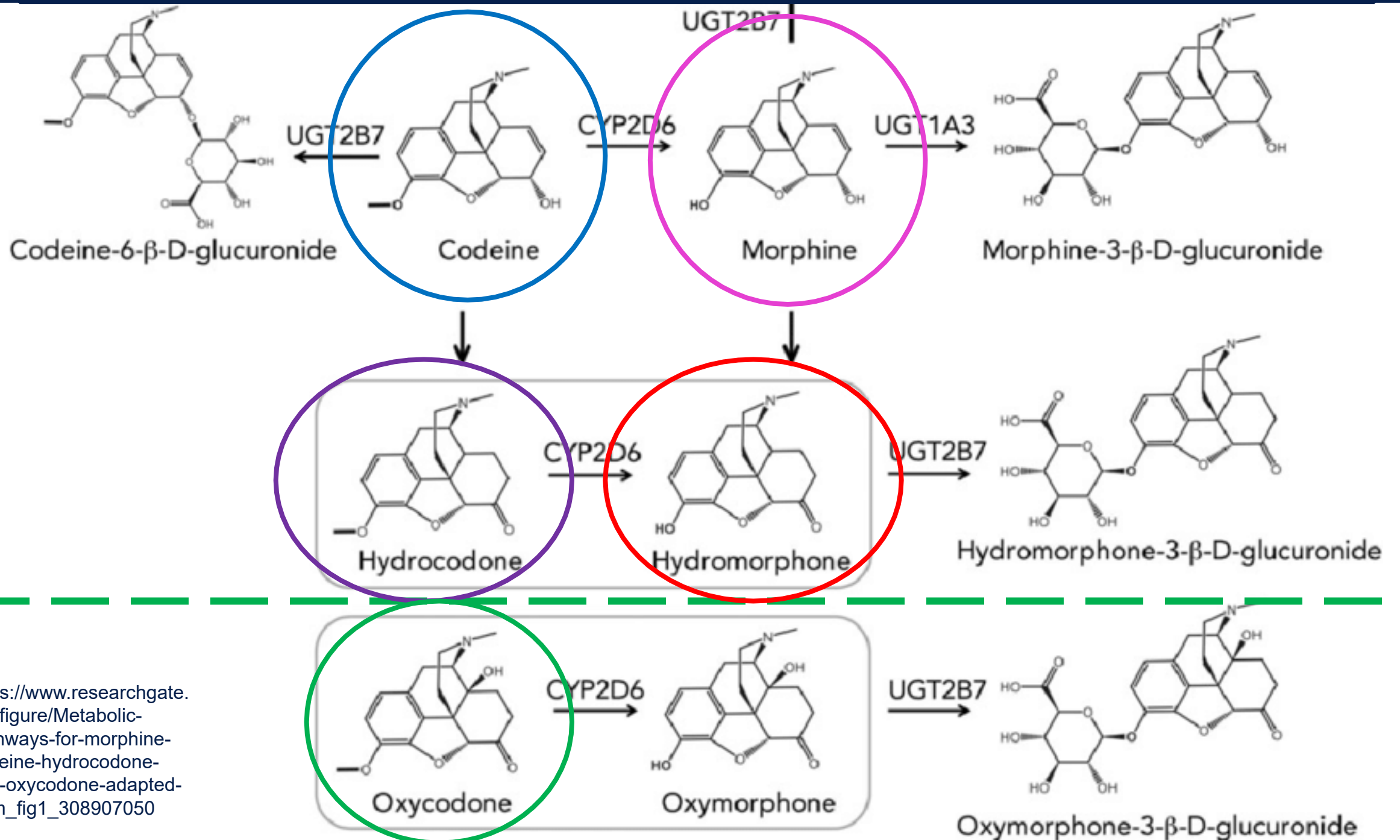

https://www.researchgate.net/figure/Metabolic-pathways-for-morphine-codeine-hydrocodone-and-oxycodone-adapted-from_fig1_308907050

HOW WOULD YOU INTERPRET THESE RESULTS?

- A.** The patient is taking methadone and morphine.
- B.** The patient is taking methadone and codeine.
- C.** The patient is taking methadone, hydromorphone, and codeine.
- D.** The patient is taking methadone, morphine, hydromorphone, and codeine.

Remember: she is prescribed IR morphine and

Answer

- A.** The patient is taking methadone and morphine.

Remember: she is positive on COMP TOX for morphine, codeine, and hydromorphone

Table 1. Laboratory Test Results

Test Performed	Method of Detection	Patient Values (Qualitative)	Patient Values, ng/mL	Assay Cutoff, ng/mL
Opiates	Immunoassay	Positive	>800	50
Codeine	Mass spectrometry	Positive	254	100
Morphine	Mass spectrometry	Positive	>50 000	100
Hydrocodone	Mass spectrometry	Negative		100
Hydromorphone	Mass spectrometry	Positive	5792	100
Norhydrocodone	Mass spectrometry	Negative		100
Oxycodone	Mass spectrometry	Negative		100



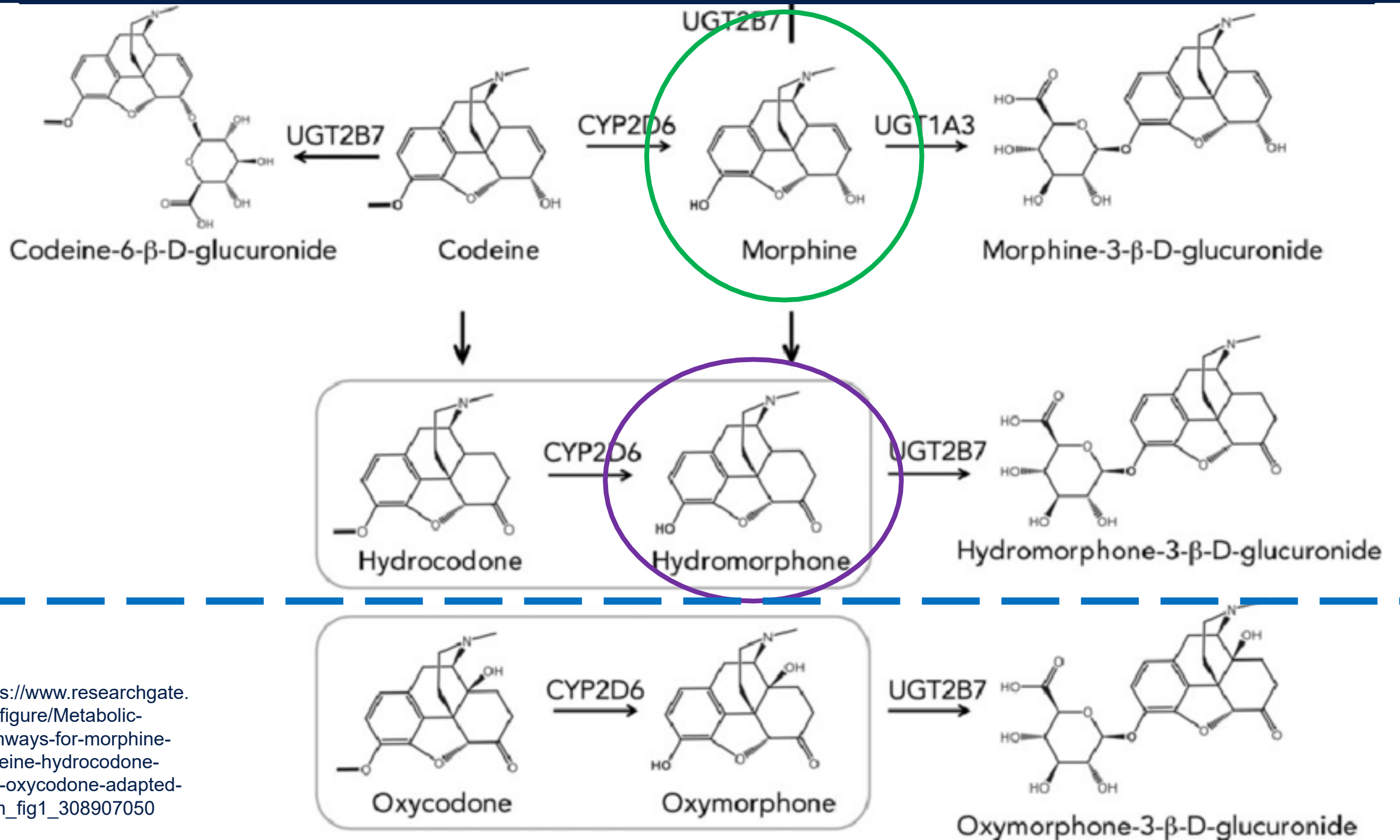

https://www.researchgate.net/figure/Metabolic-pathways-for-morphine-codeine-hydrocodone-and-oxycodone-adapted-from_fig1_308907050

Table 1. Laboratory Test Results

Test Performed	Method of Detection	Patient Values (Qualitative)	Patient Values, ng/mL	Assay Cutoff, ng/mL
Opiates	Immunoassay	Positive	>800	50
Codeine	Mass spectrometry	Positive	254	100
Morphine	Mass spectrometry	Positive	>50 000	100
Hydrocodone	Mass spectrometry	Negative		100
Hydromorphone	Mass spectrometry	Positive	5792	100
Norhydrocodone	Mass spectrometry	Negative		100
Oxycodone	Mass spectrometry	Negative		100



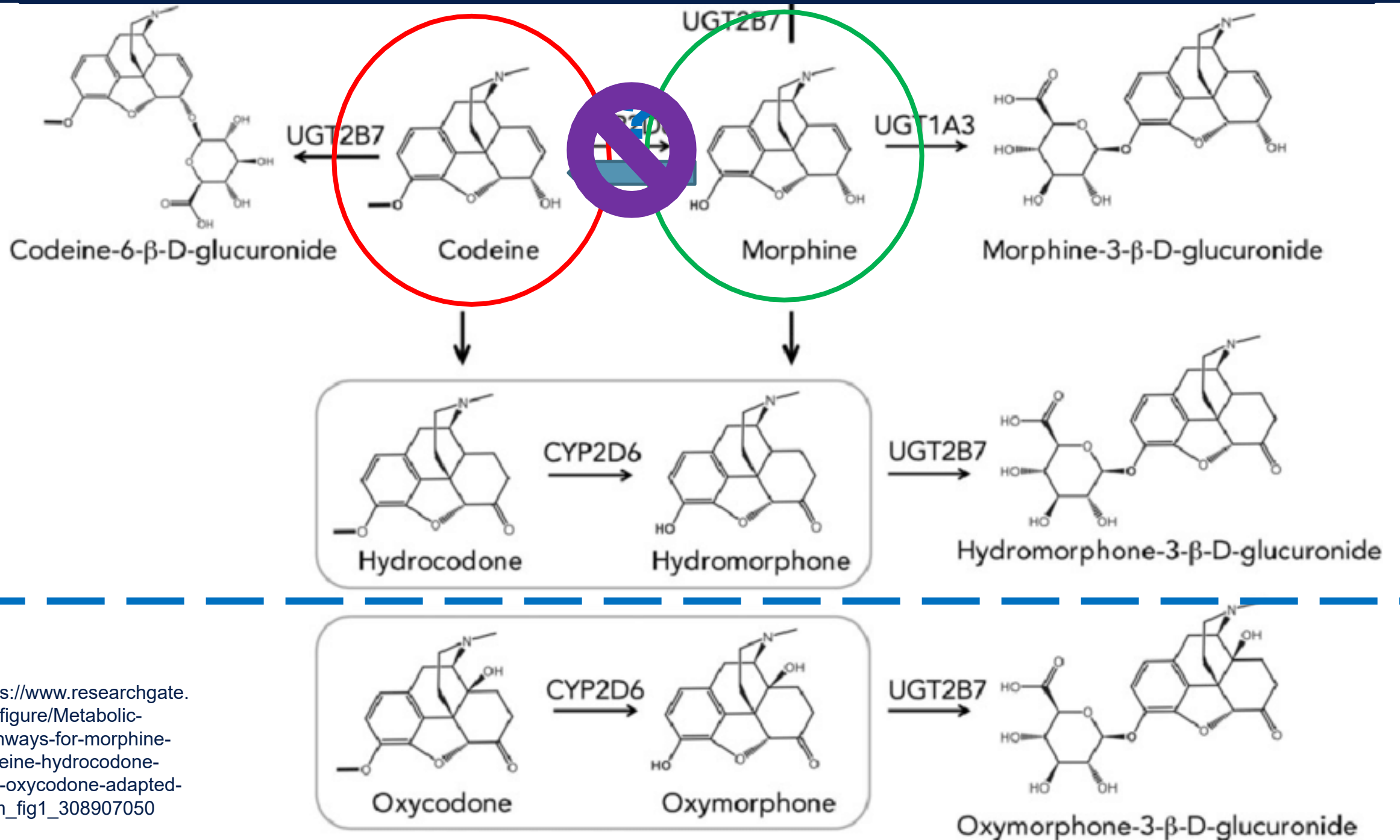

https://www.researchgate.net/figure/Metabolic-pathways-for-morphine-codeine-hydrocodone-and-oxycodone-adapted-from_fig1_308907050

Codeine Is an Impurity in the Morphine Production Process

Correspondence with one of the pharmaceutical companies producing morphine indicated that codeine sulfate is a potential process impurity in the manufacturing of morphine. It is present at a maximum limit of 0.5%. The literature indicates that there is no methylation of morphine to codeine in humans.⁹

Table 1. Laboratory Test Results

Test Performed	Method of Detection	Patient Values (Qualitative)	Patient Values, ng/mL	Assay Cutoff, ng/mL
Opiates	Immunoassay	Positive	>800	50
Codeine	Mass spectrometry	Positive	254	100
Morphine	Mass spectrometry	Positive	>50 000	100
Hydrocodone	Mass spectrometry	Negative		100
Hydromorphone	Mass spectrometry	Positive	5792	100
Norhydrocodone	Mass spectrometry	Negative		100
Oxycodone	Mass spectrometry	Negative		100

~0.5 %

~10%

Hydromorphone concentrations >10% of morphine or codeine concentrations >0.5% morphine would be consistent with the patient also taking hydromorphone or codeine



Quick Quiz

In a patient prescribed Tylenol #3 (codeine + acetaminophen), one would reasonably expect the following to be detected in the urine?

- A. Codeine
- B. Oxycodone
- C. Morphine
- D. All of the above
- E. A and C only

Quick Quiz

In a patient prescribed MS Contin (morphine), one would reasonably expect the following to be detected in the urine?

- A. Morphine
- B. Oxycodone
- C. Codeine
- D. All of the above
- E. A and C only

Note that Reisfield's work was published in 2007, two years before West's codeine contamination of morphine study was published!

Quick Quiz

A patient on Oxycontin (oxycodone) is administered a UDS. He states he ate a poppy seed danish for breakfast. What substances might reasonably be detected in the urine?

- A. Morphine
- B. Oxycodone
- C. Codeine
- D. All of the above
- E. A and C only

Take-Home Points: Minor Metabolic Pathways

☀ You may have already been aware:

☀ Hydromorphone is a metabolite of hydrocodone

☀ Analogously, oxymorphone is a metabolite of oxycodone

☀ Hydromorphone is also a minor metabolite of morphine

☀ Typically seen when morphine concentration $>10,000$ ng/mL

☀ Should be $\leq 10\%$ of the morphine concentration in urine

Take-Home Points: Contaminants

- ☀ Codeine is NOT a metabolite of morphine
 - ☀ However, it can be a minor impurity in morphine production
 - ☀ May be found at 0.04%-0.5% the concentration of morphine
- ☀ Hydrocodone is a contaminant of oxycodone production and may be present at <0.1% of the oxycodone concentration!

West, Robert, *et al.* (2009) *Therapeutic drug monitoring* 31(6): 776-778.

West, Robert, *et al.* (2011) *Clinica Chimica Acta* 412(1-2): 29-32.

#ASAMAnnual2022



A wide-angle photograph of a vast field of red poppies. The flowers are in full bloom, with vibrant red petals and green foliage. A narrow dirt path winds through the field from the foreground towards the center. In the background, there are dark green trees on the left and rolling hills under a sky filled with dramatic, layered clouds. The lighting suggests a sunset or sunrise, with golden light breaking through the clouds.

Synthetic Opioid Pathways: Fentanyl

Fentanyl Case Presentation

- ☀️ 40 y/o female methadone clinic patient

- ☀️ Past Medical History

 - ☀️ Polysubstance use (cocaine and 2-3 g IV fentanyl/day)

 - ☀️ Chronic pain

 - ☀️ Depression

 - ☀️ Housing instability (homeless upon presentation to the clinic the previous month)

Fentanyl Case Presentation

☀ Clinical Course:

- ☀ Started on methadone 20 mg/day and increased over a period of four weeks to 45 mg/day
- ☀ Attending intensive outpatient treatment 3x/week
- ☀ Living in clinic-associated recovery housing with a zero-tolerance drug use policy

Fentanyl Case Presentation

☀ Clinical Course:

- ☀ Pt appeared to be doing well with no clinical evidence of intoxication or drug use....BUT
- ☀ Routine UDS on day 23 positive for fentanyl
- ☀ Confirmatory LC/MS testing sent and also positive
- ☀ Pt discharged from her recovery housing d/t suspected relapse despite her denial

How would you interpret these results?

- ☀ Patient lied about relapsing
- ☀ Patient took fentanyl unknowingly in something else she was taking
- ☀ Patient was administered fentanyl by clinical personnel
- ☀ Or....???

Fentanyl Metabolism Major Pathways

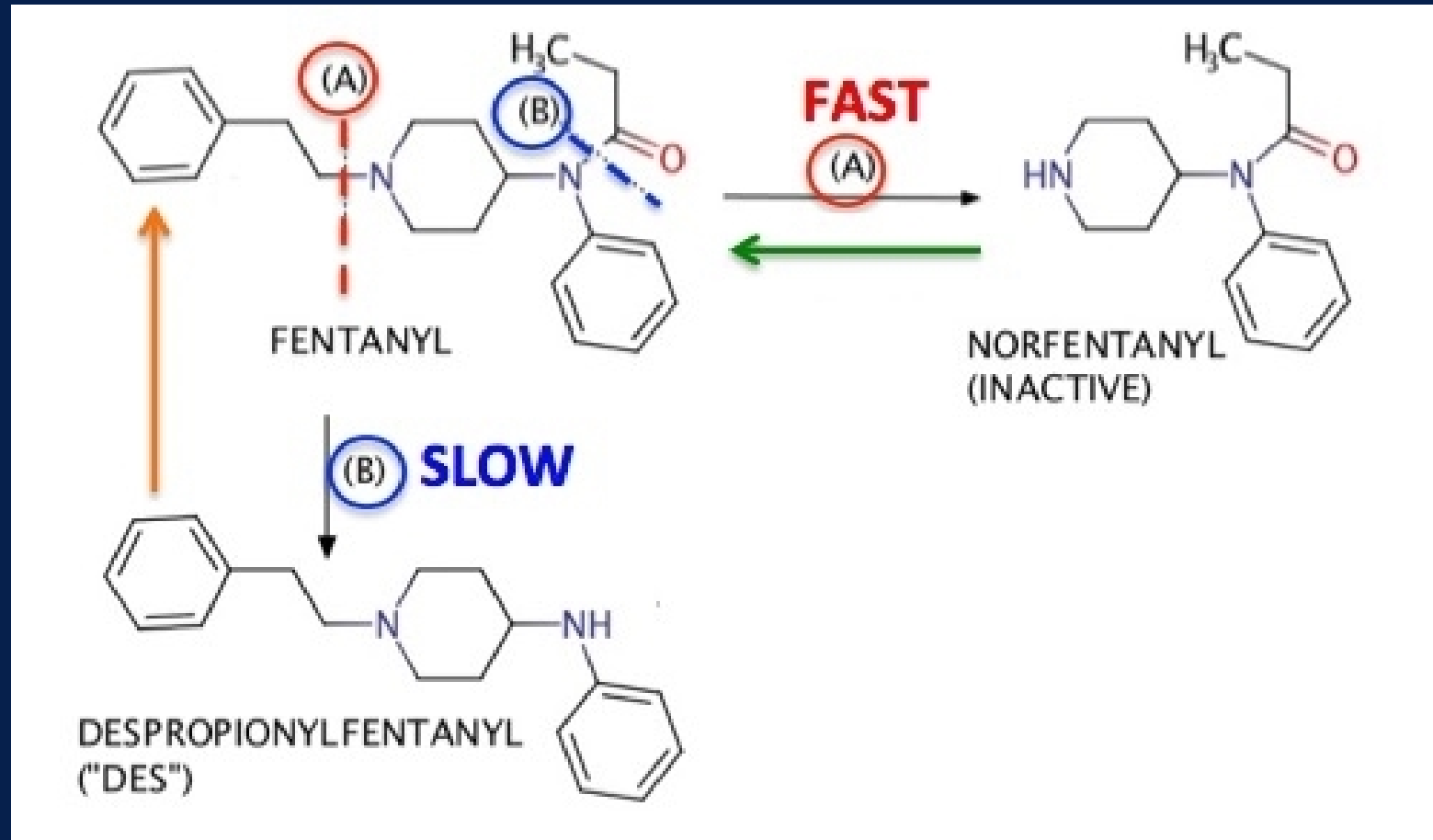

UDS and LC-MS Results During the Patient's First Two Months of Treatment

Day	Fentanyls Present on UDS	Fentanyl LC-MS/MS (ng/mL)	Norfentanyl LC-MS/MS (ng/mL)	Other Substances Present on UDS
0	Positive	20.0	337.0	–

EDDP: 2-Ethylidene-1,5-Dimethyl-3,3-Diphenylpyrrolidine, ND = Not Detected

Fentanyl and Norfentanyl Elimination

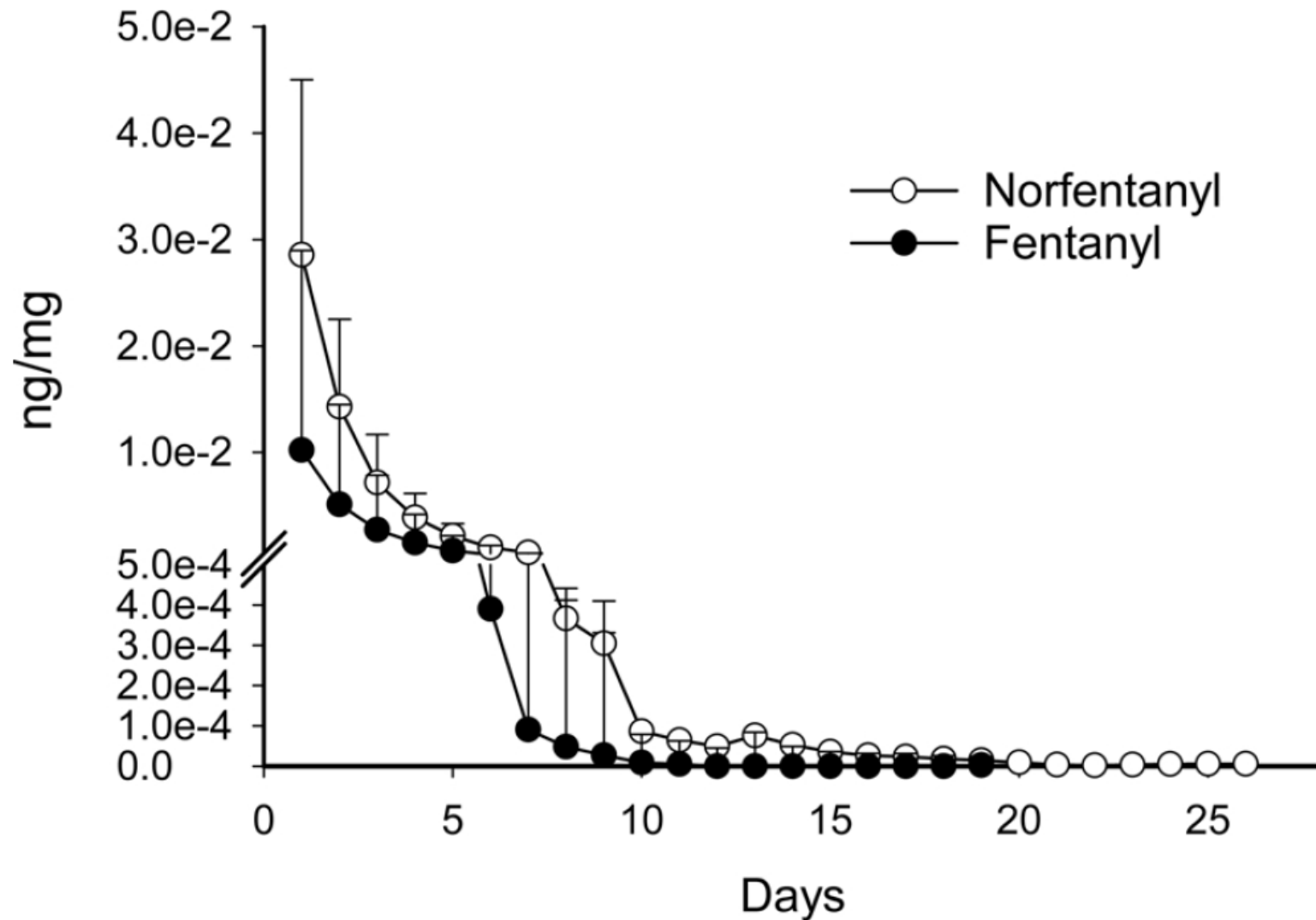

We Know THC Does This With Chronic Use....

Highest THC (ng/mL)	Time of highest (days)	Time of first negative (days)	Time of last positive (days)	Detection rate (%) ^b
11.5	0.6	11.0	12.0 ^c	100.0
11.0	0.4	1.1	7.5 ^d	86.2
8.3	1.0	0.3	3.7	64.3
6.3	1.9	0.7	3.3	44.2
8.1	0.0	1.5	7.2	70.4
17.2	0.6	1.1	24.7	85.8
5.7	3.1	1.1	4.6	61.5
9.7	1.1	2.4	9.0	72.7
8.3	0.6	1.1	7.2	70.4



And fentanyl was suspected to do this 40+ years ago!

The fact that the total body burden of fentanyl decreases very slowly should be kept in mind when considering the disposition of fentanyl following multiple doses or sustained intravenous infusions.

Fentanyl Is Lipophilic

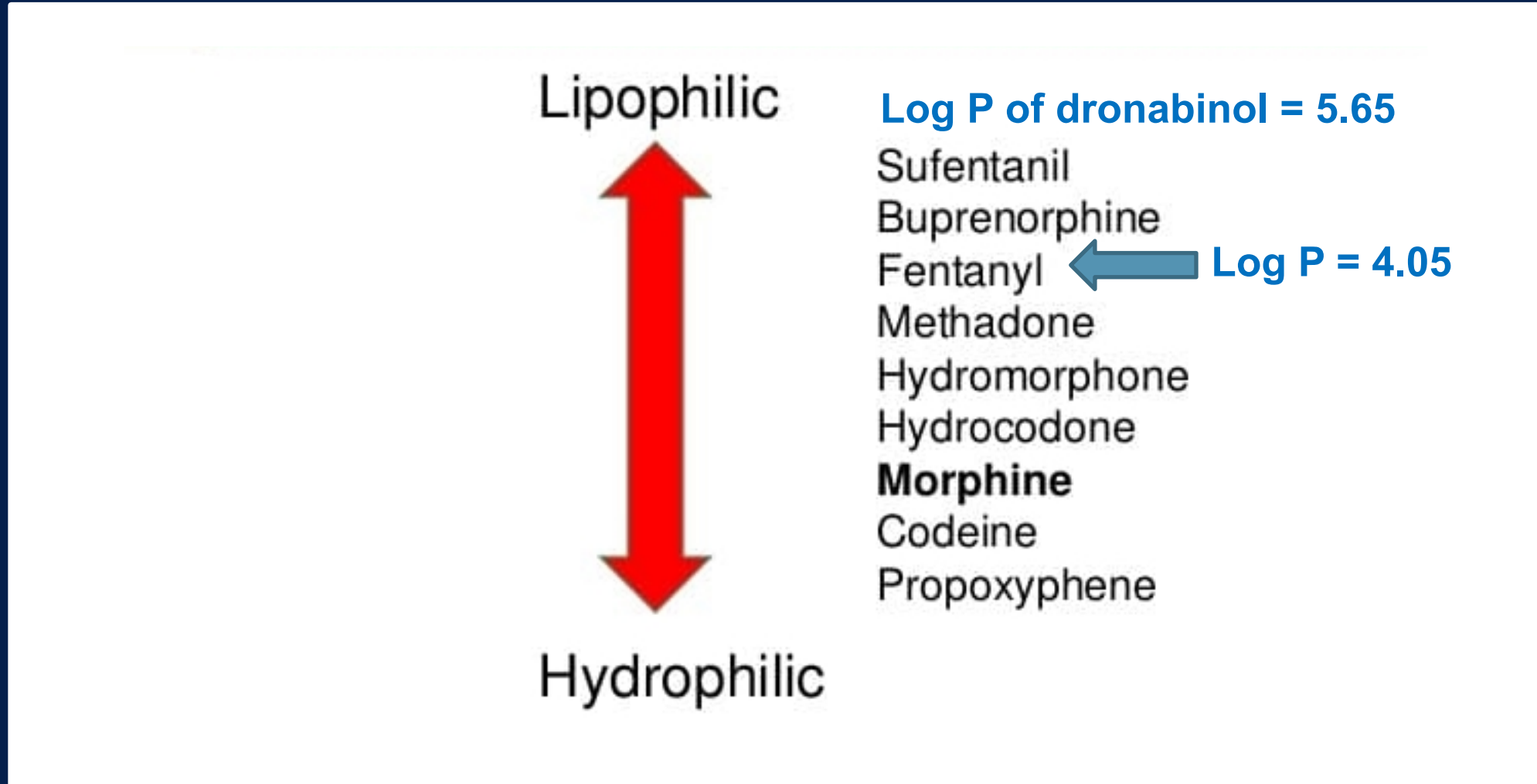

UDS and LC-MS Results During the Patient's First Two Months of Treatment

Day	Fentanyls Present on UDS	Fentanyl LC-MS/MS (ng/mL)	Norfentanyl LC-MS/MS (ng/mL)	Other Substances Present on UDS
0	Positive	20.0	337.0	–
19	–	–	–	Methadone, EDDP
23	Positive	ND	0.7	Methadone, EDDP
30	ND	–	–	Methadone, EDDP
45	ND	–	–	Methadone, EDDP
51	Positive	–	–	Cocaine, Methadone, EDDP
58	ND	–	–	Cocaine, Methadone, EDDP, Opiates

Discharge from housing →

Relapse →



EDDP: 2-Ethylidene-1,5-Dimethyl-3,3-Diphenylpyrrolidine, ND = Not Detected

One Other Fentanyl Consideration

Component Results	UDS Results	
Component	Value	Ref Range & Units
Acetaminophen Ur	NEG	<=10 mcg/mL
Amphetamine Ur	POS !	<=500 ng/mL
Corrected from PENDING ng/mL [NA] on 02/21/18 19:44:21 CST by Mix, Samantha.		
Barbiturate Ur	NEG	<=200 ng/mL
Benzodiazepine	NEG	<=200 ng/mL
Cocaine Metab Ur	NEG	<=300 ng/mL
Fentanyl, Urine	POS !	<=4 ng/mL
LSD Ur	NEG	<=25 pg/mL
Methadone Ur	NEG	<=300 ng/mL

Mass Spectrometry Urine

Amphetamine, Methamphetamine, and Diphenhydramine present.

Creat Urine

145

>=20 mg/dL

Final Takeaways/Summary

- ☀ We all recognize that UDS interpretation is fraught with traps for the unwary, but so is comp tox interpretation!
- ☀ Multiple factors can complicate interpretation of urine drug testing by chromatography-mass spectrometry:
 - ☀ Minor metabolic pathways (ex. morphine => hydromorphone)
 - ☀ Manufacturing process contaminants (ex. codeine in morphine)
 - ☀ Redistribution of lipophilic opioids (ex. fentanyl in chronic use)
 - ☀ Analogs that cross-react on UDS but haven't been added to the LC/MS library (ex. *para*-fluorofentanyl)

A wide-angle photograph of a vast field of red poppies. The flowers are in full bloom, with vibrant red petals and green foliage. A narrow, light-colored path or road winds through the field from the foreground towards the horizon. In the background, there are dark, silhouetted hills or trees under a dramatic sky filled with large, textured clouds. The lighting suggests either early morning or late afternoon, with a warm, golden glow breaking through the clouds.

Urine Drug Testing Interpretation Resources and References

Resources for Interpretation of Drug Testing

- ☀ **Appropriate Use of Drug Testing in Clinical Addiction Medicine Consensus Document**
 - ☀ <https://www.asam.org/quality-care/clinical-guidelines/drug-testing>
- ☀ Moeller KE, Lee KC, Kissack JC. Urine drug screening: practical guide for clinicians. *Mayo Clin Proc.* 2008 Jan;83(1):66-76. doi: 10.4065/83.1.66. Erratum in: *Mayo Clin Proc.* 2008 Jul;83(7):851. PMID: 18174009.
- ☀ Kapur, Bhushan M., and Katarina Aleksa. "What the lab can and cannot do: clinical interpretation of drug testing results." *Critical Reviews in Clinical Laboratory Sciences* 57.8 (2020): 548-585.
- ☀ Saitman, Alec, Hyung-Doo Park, and Robert L. Fitzgerald. "False-positive interferences of common urine drug screen immunoassays: a review." *Journal of analytical toxicology* 38.7 (2014): 387-396.
- ☀ Chua, Isaac, et al. "Provider misinterpretation, documentation, and follow-up of definitive urine drug testing results." *Journal of general internal medicine* 35.1 (2020): 283-290.

Resources: Psychoactive Substance Testing

☀️ **UNODC Early Warning Advisory (EWA) on New Psychoactive Substances (NPS)**

☀️ <https://www.unodc.org/LSS/Home/NPS>

☀️ **European Monitoring Centre For Drugs and Drug Addiction**

☀️ <https://www.emcdda.europa.eu/>

☀️ **Pubchem**

☀️ <https://pubchem.ncbi.nlm.nih.gov/>

☀️ **The Center for Forensic Science Research and Education (CFSRE) : Novel Psychoactive Substance Discovery**

☀️ <https://www.npsdiscovery.org/>

☀️ **Toxicology Investigators Consortium (ToxIC) Fentalog Study**

☀️ https://www.toxicregistry.org/Fentanyl_Analogs.html

1. In a patient prescribed Tylenol #3 (codeine and acetaminophen), one would reasonably expect the following to be detected in the urine:
a. Codeine b. Oxycodone c. Morphine d. All of the above **e. a and c only**
2. In a patient prescribed MS Contin (morphine), one would reasonably expect the following to be detected in the urine:
a. Morphine b. Oxycodone c. Codeine d. All of the above e. a and c only
3. In a patient using heroin, one would be likely to detect the following in the urine:
a. Heroin b. Hydromorphone **c. Morphine** d. All of the above e. a and c only
4. A patient on OxyContin (oxycodone) is administered a urine drug test. He states that he ate a poppy seed danish for breakfast. What substances might reasonably be detected in the urine?
a. Oxycodone b. Codeine c. Morphine **d. All of the above** e. a and c only
5. A patient on opioid therapy tests positive for cannabis on a random urine drug screen. She explains that her husband sometimes smokes pot in their bedroom. Is this a valid explanation?
a. Yes **b. No**
6. The following are valid reasons for a negative urine opiate screen in a patient on opioid therapy:
a. Patient ran out early and has not used any in a few days
b. Patient is a "fast metabolizer"
c. Drug screen does not detect that particular opioid
d. a, b and c
e. a and c only
7. A patient on chronic Dilaudid (hydromorphone) therapy tests negative for opioids on a urine drug screen. He claims to be using the medication as prescribed. The most appropriate next step would be to:
a. Subject this urine to a different kind of test
b. Re-administer a urine drug screen at the next visit
c. Taper and discontinue opioid therapy
d. Refer the patient to a detoxification/rehabilitation center
e. Notify law enforcement

#ASAMAnnual2022



Table. Expected Results on Urine Drug Screening (UDS) for Commonly Encountered Opiates, Semisynthetic Opioids, and Synthetic Opioids^a

Substance	Significant metabolites	Detected by standard UDS?	Specialized UDS available?
Opiates (natural products from the poppy plant, <i>papaver somniferum</i>)			
Morphine	Morphine-3-glucuronide, morphine-6-glucuronide	Yes ^b	NA
Codeine	Codeine-6-glucuronide, morphine, norcodeine, hydrocodone	Yes ^b	NA
Semisynthetic opioids (not naturally occurring but chemically derived from opiates)			
Heroin	6-Monoacetylmorphine, morphine	Yes ^b	NA
Hydrocodone	Norhydrocodone, hydromorphone, dihydrocodeine ^c	Sometimes ^b	Yes ^d
Hydromorphone	Hydromorphone-3-glucuronide	Sometimes ^b	Yes ^d
Oxycodone	Noroxycodone, oxymorphone	No	Yes ^d
Oxymorphone	Oxymorphone-3-glucuronide	No	Yes ^d
Buprenorphine	Norbuprenorphine, buprenorphine-3-glucuronide	No	Yes ^d
Synthetic opioids (synthesized in a laboratory and structurally distinct from opiates)			
Fentanyl	Norfentanyl, despropionylfentanyl	No	Yes ^d
Methadone	2-Ethylidene-1,5-dimethyl-3,3-diphenylpyrrolidine (EDDP)	No	Yes ^d
Tramadol	N-Desmethyltramadol, O-desmethyltramadol	No	Yes ^d
Loperamide	N-Desmethyl-loperamide	No	No ^d
Miscellaneous (opioid natural product not belonging to the above categories)			
Mitragynine (Kratom)	7-Hydroxymitragynine	No	Yes ^d



References

1. Reisfield, G.M., Goldberger, B.A. and Bertholf, R.L. (2009) 'False-positive'and 'false-negative'test results in clinical urine drug testing. *Bioanalysis*, 1(5): 937-952.
2. Arthur, J. A. (2020) Urine drug testing in cancer pain management. *The oncologist*, 25(2): 99-104.
3. Reisfield, G.M., *et al.*, (2007) Urine drug test interpretation: what do physicians know? *Journal of opioid management*, 3(2): 80-86.
4. Reisfield, Gary M., *et al.* (2007) "Family physicians' proficiency in urine drug test interpretation." *Journal of Opioid Management*, 3(6): 333-337.
5. Starrels, Joanna L., *et al.* (2012)"They don't know what they don't know: Internal medicine residents' knowledge and confidence in urine drug test interpretation for patients with chronic pain." *Journal of general internal medicine* 27(11): 1521-1527.
6. Suzuki, Joji, *et al.* (2018) "Psychiatry residents' and fellows' confidence and knowledge in interpreting urine drug testing results related to opioids." *Substance abuse* 39(4): 518-521.
7. Chua I, *et al.* (2020) Provider misinterpretation, documentation, and follow-up of definitive urine drug testing results. *Journal of general internal medicine*. 35(1):283-90.
8. Nagpal, G., Heiman, H., & Haymond, S. (2017). Interpretation of urine drug screens: metabolites and impurities. *Jama*: 318(17) 1704-1705.

References

9. West, Robert, *et al.* (2009) Anomalous observations of codeine in patients on morphine. *Therapeutic drug monitoring* 31(6): 776-778.
10. Cone, E. J. *et al* (2006). Evidence of morphine metabolism to hydromorphone in pain patients chronically treated with morphine. *Journal of analytical toxicology*, 30(1): 1-5.
11. West, Robert, *et al.* (2011) "Anomalous observations of hydrocodone in patients on oxycodone." *Clinica Chimica Acta* 412(1-2): 29-32.
12. Weiss, S.T., Chinn, M. and Veach, L., (2021) Reconsidering Reliance on Confirmatory Drug Testing in a Patient With Repeated Positive Urine Drug Screen Results: A Teachable Moment. *JAMA internal medicine*, 181(12): 1637-1638.
13. Huhn AS, *et al.* (2020) Protracted renal clearance of fentanyl in persons with opioid use disorder. *Drug and alcohol dependence*; 214: 108147.
14. Lowe, Ross H., *et al.* (2009)"Extended urinary Δ 9-tetrahydrocannabinol excretion in chronic cannabis users precludes use as a biomarker of new drug exposure." *Drug and alcohol dependence* 105(1-2): 24-32.
15. Schleimer, Robert, *et al.* (1978) "Pharmacokinetics of fentanyl as determined by radioimmunoassay." *Clinical Pharmacology & Therapeutics* 23(2): 188-194.